



Product Description

NGA Bitstream Plus Products



Product Description – open eir NGA, Bitstream Plus

Version Control

Version	Status	Update	Effective Date
2.6		Addition of Copper Line Minimum Standard - Section 3.2	November 2nd 2015
V3.0	Final	This document is based on V2.6 Implementation of Standardised Change Control.	16/06/2017
V3.1	Proposed	Addition of Wholesale Bitstream Plus GPON Ethernet Access Services over FTTH (GEA)	01/09/2019

This document follows change control procedure:

Proposed is defined as a document status when the approved document is uploaded to Proposals Section of open eir Website.

Final is defined as a document status when the approved document is uploaded to the relevant section of the open eir Website following the publication period.

For information:

- Historical Document History Table located at end of Document.
- Publish means the action of uploading a document to the website regardless of status or location.
- If there are changes to the document between 'Proposed' and 'Final', change control operates.



Table of Contents

1. Introduction	8
2. Products Overview	109
2.1 Bitstream Plus Access Components	1342
3. Product Features	14
3.1 Fibre Product Features	14
3.2 Copper Product Features	14
3.3 Key Benefits	15
3.4 Unicast Redundancy	16
3.5 Multicast Redundancy	16
3.6 VLAN Management	16
3.7 Vectoring Standard (FTTC)	16
3.8 NTU Installation (FTTC)	16
4. Bitstream Plus logical connectivity	1817
4.1 Bitstream Plus Unicast	1847
4.2 Multicast Principles	1948
4.3 Bitstream Plus Multicast	2049
4.4 Operators Handoff Point	2224
4.5 Traffic-based Class of Service	2322
4.6 CPE Management	2322
4.7 Ordering the Bitstream Plus Logical Connectivity Service	2423
5. FTTH Bitstream Plus	2524
5.1 FTTH Bitstream Plus POTS-Based	2524
5.2 FTTH Bitstream Plus GEA	2625
5.3 FTTH Bitstream Plus GEA O.O.S.	2726
5.4 FTTH Bitstream Plus Service Presentation	2726
6. FTTC Bitstream Plus	2928
6.1 FTTC Bitstream Plus POTS-Based	2928
6.2 FTTC Line Profiles	3029
6.3 FTTC Bitstream Plus VEA	3130
6.4 FTTC Bitstream Plus VEA OoS	3230
7. Bitstream Plus Access – Ordering and Assurance	3332
8. Billing	3332
9. Commercial	3332
9.1 Pricing	3332
9.2 Terms and Conditions	3332
Version Control History	3433
1. Introduction	7



Product Description – open eir NGA, Bitstream Plus

2. Products Overview	8
2.1 Bitstream Plus Access Components	9
3. Product Features	11
3.1 Fibre Product Features	11
3.2 Copper Product Features	11
3.3 Key Benefits	12
3.4 Unicast Redundancy	13
3.5 Multicast Redundancy	13
3.6 VLAN Management	13
3.7 Vectoring Standard (FTTC)	13
3.8 NTU Installation (FTTC)	13
4. Bitstream Plus logical connectivity	14
4.1 Bitstream Plus Unicast	14
4.2 Multicast Principles	15
4.3 Bitstream Plus Multicast	16
4.4 Operators Handoff Point	18
4.5 Traffic based Class of Service	19
4.6 CPE Management	19
4.7 Ordering the Bitstream Plus Logical Connectivity Service	20
5. FTTH Bitstream Plus	21
5.1 FTTH Bitstream Plus POTS Based	21
5.2 FTTH Bitstream Plus Service Presentation	22
6. FTTC Bitstream Plus	23
6.1 FTTC Bitstream Plus POTS Based	23
6.2 FTTC Line Profiles	24
6.3 FTTC Bitstream Plus VEA	25
6.4 FTTC Bitstream Plus VEA QoS	25
7. Bitstream Plus Access – Ordering and Assurance	27
8. Billing	27
9. Commercial	27
9.1 Pricing	27
9.2 Terms and Conditions	27
Version Control History	28



List of Figures

Figure 1: open eir NGA Bitstream Plus Access Products	887
Figure 2: open eir NGA Bitstream Plus	1098
Figure 3: open eir NGA Bitstream Plus VDSL Ethernet Access	11409
Figure 4: Copper Line Minimum Standard	154542
Figure 5: Bitstream Plus Unicast Service	181714
Figure 6: Multicast Principles	194815
Figure 7: Bitstream Plus Multicast Service	204946
Figure 8: Bitstream Plus Multicast Service with multiple Egress Groups	212047
Figure 9: Operators Handoff Point	222418
Figure 10: Mapping of C-VLAN p-bits to Forwarding Classes	232249
Figure 11: Bitstream Plus Multicast Orders	242320
Figure 12: FTTH Bitstream Plus Standalone	252421
Figure 13: FTTH Bitstream Plus POTS-Based	252421
Figure 14: Fibre STP for FTTH Bitstream Plus	272622
Figure 15: FTTC Standalone Bitstream Plus	292823
Figure 16: FTTC Bitstream Plus POTS-Based	292823
Figure 17: FTTC Profiles	302924
Figure 18: Bitstream Plus VDSL Ethernet Access Bandwidth Profiles	313025
Figure 19: VDSL Ethernet Access QoS Options	323426



Acronyms

AF	Assured Forwarding
AN	Access Node
BE	Best Effort
BP	Bitstream Plus
BTV	Broadcast Television
CoS	Class of Service
CPE	Customer Premises Equipment
CSID	Calling Station ID
EF	Expedited Forwarding
FTTC	Fibre to the Cabinet
FTTH	Fibre to the Home
GEA	GPON Ethernet Access
GPON	Gigabit-capable Passive Optical Network
GLUMP	Geographic Local Unbundled Metallic Path
IGMP	Internet Group Management Protocol
M-VPN	Multicast – Virtual Private Network
MPLS	Multi-Protocol Label Switching
NGA	Next Generation Access
NGA-AN	Next Generation Access – Access Node
NGN	Next Generation Network
NTP	Network Termination Point
NTU	Network Terminating Unit
OLT	Optical Line Terminal
ONT	Optical Network Terminal
PB	POTS Based
PoH	Point of Handover
PON	Passive Optical network
POTS	Plain Old Telephone Service
QoS	Quality of Service
RG	Residential Gateway
SA	Standalone
SAB	Service Access Bandwidth
SB-WLR	Single Billing - Wholesale Line Rental
STB	Set-top Box
UG	Unified Gateway
ULMP	Unbundled Local Metallic Path
VLAN	Virtual Local Area Network
VLL	Virtual Leased Line



Product Description – open eir NGA, Bitstream Plus

VPLS	Virtual Private LAN Service
VAS	Value Added Service
VEA	VDSL Ethernet Access
VoIP	Voice over Internet Protocol
VOD	Video on Demand
VDSL	Very high bit-rate Digital Subscriber Line
WEIL	Wholesale Ethernet Interconnect Link



Product Description – open eir NGA, Bitstream Plus

1. Introduction

This document provides the product description for the open eir¹ NGA Bitstream Plus product set. The NGA Bitstream Plus product set is a subset of the overall Bitstream Plus product set, which also includes current generation access products. The table below outlines the individual products covered by this product description.

Access Medium	POTS ² Support	Product
Fibre to the Home (FTTH)	No	FTTH Bitstream Plus SA (Standalone) FTTH Bitstream Plus SA GEA (Standalone)
	Yes	FTTH Bitstream Plus PB (POTS-based)
Fibre to the Cabinet (FTTC)	No	FTTC Bitstream Plus SA (Standalone)
	Yes	FTTC Bitstream Plus PB (POTS-based.)
Fibre to the Cabinet (FTTC)	No	FTTC Bitstream Plus VEA SA (Standalone)
	Yes	FTTC Bitstream Plus VEA PB (POTS-based)

Formatted: Left

Figure 1: open eir NGA Bitstream Plus Access Products

All Bitstream Plus products provide generic Ethernet access between an end-customer's premises and an Operator's own network and are intended to support a mix of time sensitive and high volume applications. These include voice, general entertainment (including Broadcast TV), and high speed Internet.

Bitstream [PlusPlus](#) VDSL Ethernet Access (VEA) and [Bitstream Plus GEA Ethernet Access \(GEA\)](#) offers a highly secure QoS enabled asymmetrical access product suitable for the business market.

Bitstream Plus products are differentiated in terms of the physical medium used to connect the end-customer to the open eir network. This document covers the open eir Next Generation Access, products. These open eir NGA Bitstream Plus products are delivered over Fibre to the Home (FTTH) or Fibre to the Cabinet (FTTC). Two distinct products, Standalone (SA) or POTS-Based (PB), are available over each access medium, as shown in [Figure 1](#), above.

This product description is subject to review and may be re-issued to reflect changes, as new products are added to the range, or enhancements to existing products are made. All such changes will be communicated in accordance with agreed industry practices.

The document should be read in conjunction with the associated documents, listed on page 2. Any specific technology mentioned in this document is current as at date of issue and is for guidance purposes only. open eir reserves the right to adapt the technology used to deliver the NGA Bitstream Plus Product, at any time.

¹ open eir is a trading name of eircom Limited, Registered as a Branch in Ireland Number 907674, Incorporated in Jersey Number 116389, Branch Address: 1 Heuston South Quarter, St. John's Road, Dublin 8

² POTS is an acronym for 'plain old telephone service', and refers to the analogue telephone service provided over a copper twisted pair landline. It is used to distinguish that service from other voice services, such as a Voice over Internet Protocol (VoIP) service provided over an all-digital network.



Product Description - open eir NGA, Bitstream Plus

2. Products Overview

The open eir NGA Bitstream Plus product range consists of Layer 2 Ethernet-only access products, giving the Operator full control of network protocols. Each NGA Bitstream Plus product provides an enhanced broadband access service, between the service termination / demarcation point at an end-customer premises and a WEIL³, **at an Operator's nominated handover point**⁴ within the NGN Aggregation Node. All Bitstream Plus products support traffic-based Class of Service to allow time-critical applications, such as Voice over IP, be prioritised. Further flexibility is provided by including Multicast Support, for cost-effective distribution of TV and other broadcast services.

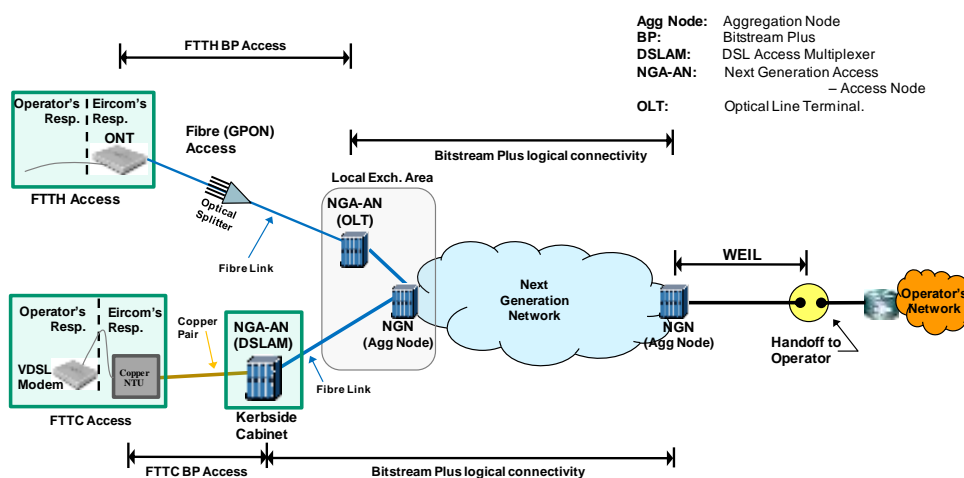

Figure 2: open eir NGA Bitstream Plus

Bitstream Plus products are designed to use either copper or fibre as the physical access medium, as shown in [Figure 2](#). FTTH⁵ Bitstream Plus products are used where fibre is the access medium and FTTC⁶ Bitstream Plus where copper is the access medium. Two variants of each, Standalone (SA) or POTS⁷-based (PB), are available.

The demarcation point varies, depending on the access medium used. Where services are delivered over fibre the demarcation point is the interface on an Optical Network Terminal. Where Services is delivered over copper, the demarcation point is the copper Network Terminating Unit.

VDSL Ethernet Access Services over FTTC will be provided using VDSL2 technology in the access network and NGN in the Core network.

Formatted: English (U.K.)

Formatted: English (U.K.)

³Wholesale Ethernet Interconnect Link

⁴Generally known as the Point of Handover (POH)

⁵Fibre to the Home

⁶Fibre to the Cabinet

⁷POTS is an acronym for 'Plain Old Telephone Service'..

Product Description – open eir NGA, Bitstream Plus

This service offering will allow wholesale customers send either untagged, single C-VLAN or double C-VLAN tagged traffic on an FTTC access. This traffic will be mapped into the NGN service and will preserve the original customer tagging across the network to the handover point. There is a one to one relationship between the FTTC access circuit and the NGN service.

Figure 3 below provides a visual representation of the proposed product

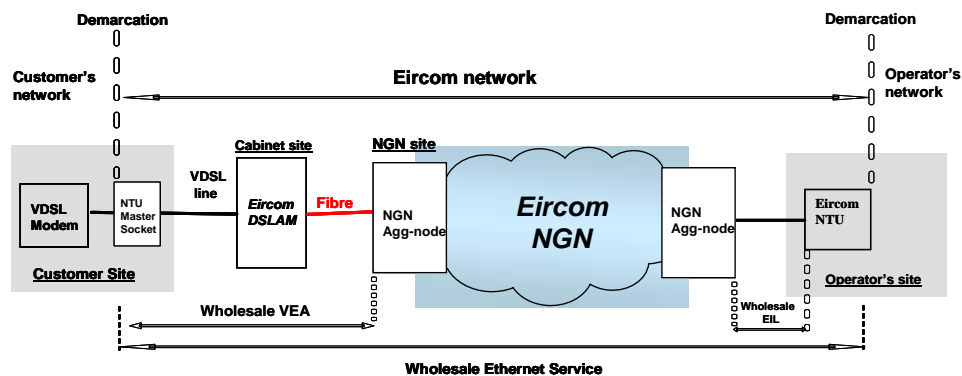

Figure 3: open eir NGA Bitstream Plus VDSL Ethernet Access

The physical connectivity for the VEA access connection incorporates the following;

master socket at the end customer's site the copper pair between the customer's site and the DSLAM street Cabinet the physical port on the DSLAM.

The open eir VDSL Ethernet Access service over FTTC consist of the following components:

Wholesale VDSL Ethernet Access provides (physical) connectivity from an End User site to the Cabinet DSLAM. This will have circuit designation VEA

Logical connection (WES) that provides a (logical) E-line service between an Operator's End Customer's site and the Operators handover site.

The Bitstream Plus VDSL Ethernet Access products are designed to use copper as the physical access medium. Two variants of each, Standalone (SA) or POTS⁸-based (PB), are available. The demarcation point is the copper Network Terminating Unit.

[GEA Ethernet Access Services over FTTH will be provided using GPON technology in the access network and NGN in the Core network. The product will be available as Standalone \(SA\) 1 gig FttH only.](#)

[This service offering will allow wholesale customers send either untagged or double tagged traffic on an FTTH access. This traffic will be mapped into the NGN service and will preserve the original customer tagging across the network to the operator's handover point. There is a one to](#)

⁸POTS is an acronym for 'Plain Old Telephone Service'.

Product Description – open eir NGA, Bitstream Plus

one relationship between the FTTH access circuit and the NGN service. Only one logical WES can be supported on an individual physical GEA.

Figure 4 below provides a visual representation of the proposed product

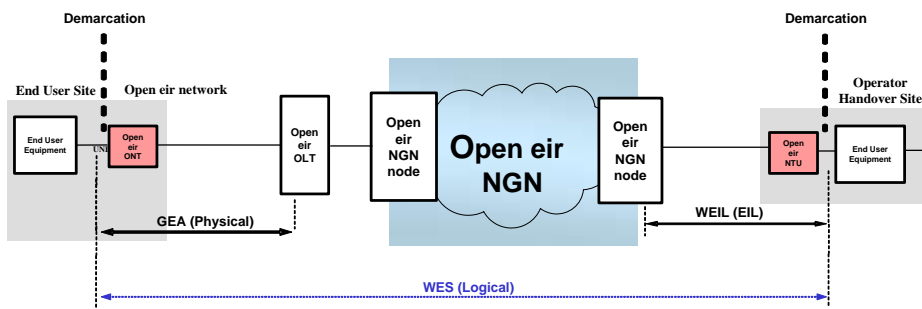

The physical connectivity for the GEA access connection incorporates the following:

- ONT master socket at the end user site
- Fibre path via an optical splitter between the end user site and the NGA access node (OLT) in the exchange.

The open eir GEA Ethernet Access service over FTTH consists of the following components:

- 1) Wholesale Bitstream GPON Access (GEA) provides (physical) connectivity from an End User site to the OLT in an open eir Exchange.
- 2) Wholesale Ethernet Interconnect Link (EIL) provides (physical) connectivity from an Operator's handover site to the NGN Aggregation node.
- 3) WSEA Logical connection (WES) provides a (logical) E-line service between an Operator's End User site and the Operators handover site.

Multiple WES connections may be aggregated within the Open eir NGN network and handed-over to an Operator on an EIL. Only one logical WES connection can be supported on an individual physical GEA.

- Formatted:** Not Highlight
- Formatted:** Font: GT Walsheim Regular
- Formatted:** Font: GT Walsheim Regular, Not Bold
- Formatted:** Font: GT Walsheim Regular
- Formatted:** Left
- Formatted:** Font: GT Walsheim Regular
- Formatted:** Font: GT Walsheim Regular, Not Bold
- Formatted:** Font: GT Walsheim Regular
- Formatted:** Font: GT Walsheim Regular, Not Bold
- Formatted:** Font: GT Walsheim Regular



Product Description – open eir NGA, Bitstream Plus

2.1 Bitstream Plus Access Components

Bitstream Plus Access products comprise a number of distinct components that can be divided into two categories:

- Connectivity components, common to all end-customers.
- Access mechanisms, ordered individually for each end-customer.

In addition, provision of any element of the product is dependent on the presence of a Wholesale Ethernet Interconnect Link (WEIL) connection to the Operator network upon which capacity is nominated specifically for Bitstream Plus traffic.

There are two types of connectivity services available, namely Unicast and Multicast. The basic Bitstream Plus service is based on Unicast⁹, which is mandatory for all Bitstream Plus products. **This supports an individual connection between the Operator's network and each active session for an end-customer, or Application.** Unicast is ideal for applications such as Internet browsing and Video on Demand.

Bitstream plus products also support Multicast¹⁰, which is available as an additional Bitstream Plus service. Multicast allows multiple end-customers to access a single broadcast stream, such as a TV program and makes more efficient use of the Operator's network for this type of material. Multicast connectivity also requires Unicast connectivity to be in place.

Once the WEIL is in place, an Operator can order Unicast and Multicast logical connectivity for each of its resellers¹¹, to individual NGN Aggregation Nodes within the open eir network. The existence of a Unicast logical connection to an NGN Aggregation Node is a pre-requisite to providing service to individual end-customers. In addition, if an Operator wishes to provide Multicast services, they must have Multicast logical connectivity in place before service can be provided to an individual end-customer.¹²

It will not be possible to provision multicast on the Bitstream Plus VEA [or Bitstream Plus GEA](#) products.

⁹ Unicast transmission is the sending of messages to a single network destination identified by a unique address.

¹⁰ Multicast is the delivery of a message or information to a group of destination computers simultaneously in a single transmission from the source.

¹¹ An Egress Group is required for each of an Operator's Bitstream Plus resellers

¹² Multicast connectivity (per Egress Group) is not standalone and is only provided in conjunction with associated Unicast connectivity per Egress Group.



3. Product Features

All Bitstream Plus products share the following feature set:

- Layer 2 Ethernet-only access - allowing Operators to differentiate their services at the Internet Protocol (IP) Layer and above.
- Support for traffic-based Class of Service (CoS).
- Support for circuit-based Class of Service (CoS) on Bitstream Plus VEA [and Bitstream Plus GEA variant](#).
- Support for Multicast Injection and Replication.¹³ (Excluding Bitstream Plus VEA variant [and Bitstream Plus GEA variant](#))
- Handover of Ethernet Traffic to Operator using a WEIL.^{14,15}
- Connectivity is extended automatically as the available footprint, within a Local Exchange Area, expands.
- Usage-based Unicast Billing based on 95th Percentile bandwidth measurement. (Excluding Bitstream Plus VEA [and Bitstream Plus GEA variant](#))
- Multicast Billing based on reserved NGN Core Bandwidth.
- Supports multiple, geographically dispersed, handovers, for traffic management and resilience.
- Core services based on Virtual Private LAN Service (VPLS), for maximum flexibility and scalability.
- The support of multiple-VPLS, to enable an Operator to resell service to multiple operators
- NGN Infrastructure will be managed by open eir to ensure that there is no network congestion.^{16,17}

3.1 Fibre Product Features

The following additional features apply to Bitstream Plus products delivered to the end customer over fibre:

Guaranteed Unicast Bandwidth, downstream and upstream.

Additional bandwidth available for Multicast.

3.2 Copper Product Features

The following additional features apply to Bitstream Plus products delivered to the end customer over copper:

¹³ Multicast Solution supports IGMPv2 and IGMPv3.

¹⁴ A Wholesale Ethernet Interconnect Link (WEIL) is a separate product with its own product description, and supporting collateral.

¹⁵ The full range of available WEIL handoffs, e.g. in-building, in-span and customer-sited, are supported.

¹⁶ On-going capacity management of the handoff WEIL, to ensure sufficient Unicast and Multicast bandwidth, is the responsibility of the Operator.

¹⁷ Under normal network conditions



Product Description – open eir NGA, Bitstream Plus

- Products are ‘Up To’ – i.e. the maximum attainable bandwidth, for a typical access line, are specified.¹⁸
- Individual installations can be configured for High Speed Internet¹⁹ or with a Stable Profile²⁰
- Service terminates on a Copper NTU in a “Wires Only” solution.
- Operator provides own DSL Modem.²¹
- Multicast Traffic shares available bandwidth with Unicast.
- The DSL Line Profile can be changed by the Operator, up to the maximum bandwidth supported by the copper line.

Line Test Parameter	Normal minimum standard
A-Earth	>1MΩ
B-Earth	>1MΩ
A-B	>250kΩ
B-Neg	>1MΩ
B-Neg	>1MΩ
AC Voltage	<3V
DC Voltage	<5V
Balance (Capacitance)	>85%

Figure 4: Copper Line Minimum Standard

3.3 Key Benefits

The foregoing features provide the following key benefits, for Operators:

- Operators can add ultra-high speed Broadband, and multi-play options, to their product portfolio.
- Operators can choose their own AAA (Authentication, Authorisation & Accounting) solution.
- Operators can design individual Multicast Solutions, independent of other Operators implementation.²²
- Operators can prioritise individual customer services, in terms of the Quality of Service required.
- Operators can provide their own VoIP Solution, or use open eir-provided POTS.
- Operators can resell to multiple resellers
- Bitstream Plus VEA allows operators to have either untagged, single C-VLAN or double C-VLAN tagged traffic on a FTTC access
- Multiple Service Multiplexing over NGA Bitstream Plus VEA

¹⁸The actual attainable bandwidth depends on the characteristics of the individual copper line, and associated DSL equipment.

¹⁹High Speed Internet is ‘Rate Adaptive’ in both directions. It gives maximum bandwidth, with minimum latency.

²⁰The Stable profile is designed primarily for IPTV and is non Rate Adaptive in the downstream direction.

²¹Choice of equipment is a matter for the Operator. The DSL Modem could be a standalone item or the functionality could be incorporated into more complex Customer Premises Equipment, such as a Residential Gateway. In any case the DSL functionality must comply with the Copper Loop Frequency Management Plan, and any other criteria that might be specified by open eir from time-to-time.

²²An Operator can use any valid Multicast Address Range, regardless of what addressers other Operators use.



Product Description – open eir NGA, Bitstream Plus

- Tunnelling of Bridge PDUs

3.4 Unicast Redundancy

Bitstream Plus Unicast redundancy allows the Operator to order multiple BPU logical connections to multiple WEILs, in order to provide redundancy for the same BPU access traffic. The VPLS is local to the NGN node and there are separate services going to the different WEILs. This protects against failure of the BPU connection or the WEIL. Broadcast traffic (e.g. DHCP Discover messages) will be forwarded to both WEILs. Unicast traffic will be forwarded to one WEIL based on MAC learning in the VPLS. Split horizon is applied to the VPLS to prevent routing loops.

3.5 Multicast Redundancy

Bitstream Plus Multicast redundancy allows the Operator to order multiple BPM logical connections to multiple WEILs, in order to provide redundancy for the same BPM access traffic. The VPLS service on the NGN node is connected to two separate PE nodes within an NGN region. This protects against failure of the BPM connection or the WEIL. If both WEILs are advertising the RP in BGP, then IGMP joins will be forwarded based upon BGP best path selection. The Operator can influence this using the MED. Split horizon is applied to the VPLS to prevent routing loops.

3.6 VLAN Management

End-user CPE: The Operator is required to tag traffic with a VLAN (VLAN ID 10).

3.7 Vectoring Standard (FTTC)

Operators are obliged to ensure that all equipment connected to the network is compliant with Recommendation ITU-T G.993.5 for vectoring and with the FTTC CPE Requirements section of the Technical Handbook - Wholesale NGA National Deployment.

3.8 NTU Installation (FTTC)

Operators have the option to install the customer NTU on behalf of open eir on an exchange by exchange basis. Once an Operator has selected an exchange where they will install the NTU then all customers of that Operator in that exchange that do not have an existing NTU, must have the NTU installed by that Operator.



Product Description - open eir NGA, Bitstream Plus

4. Bitstream Plus logical connectivity

Bitstream Plus products avail of the logical connectivity to configure the connection between the Operator's network and the NGN Aggregation Node. This logical connectivity links each access node (NGA-AN)²³ and the Operator's nominated Wholesale Ethernet Interconnect Link (WEIL)²⁴. The means of ordering and assuring this Bitstream Plus logical connectivity service is common, across all Bitstream Plus products. It must be ordered individually for each reseller, for each NGN Aggregation Node. Multiple handoffs, for resilience or load sharing, are supported with a separate logical connection required for each. As the open eir NGA footprint expands, and additional NGA access nodes are added to a NGN Aggregation Node, the connectivity is automatically extended, without further Operator intervention.

4.1 Bitstream Plus Unicast

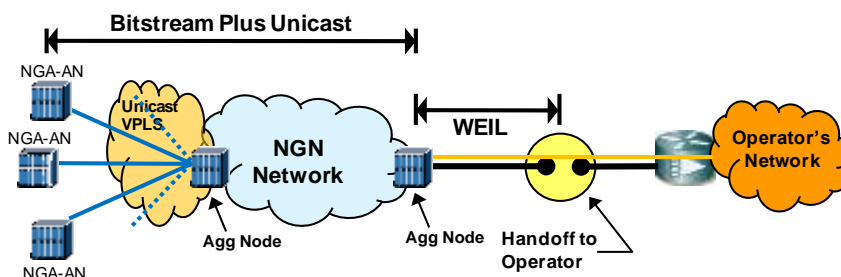

Figure 5: Bitstream Plus Unicast Service

The core Bitstream Plus connectivity is Unicast which supports an individual connection for each active session for an end-customer, or application. Unicast traffic, from each access node within an NGN Aggregation Node footprint, is assigned to a single Virtual Private LAN Service (VPLS)²⁵. Additional access nodes within that area will be joined to the VPLS by open eir, as the Bitstream Plus footprint expands. Traffic from individual end-customers is uniquely identified by means of the CSID (Calling Station Identifier) which is included in each information frame transmitted. Aggregated traffic, from all end-customers within that NGN Aggregation Node footprint is then presented in a single VLAN, at the Point of Handover. The Option82 Calling Station ID (CSID) format is as follows:

Fibre access:

<OLT Name>xpon<Frame>/<Slot>/<Port>:<ONT>.<GEM>.<VLAN>
 e.g. SND99 xpon 0/1/0:6.1.10

VDSL2 access:

<MDF>_<Cabinet><Node> eth <Frame>/<Slot>/<Port>

²³Each end-customer is connected to the NGN network via an access node. The type of node varies, depending on the access medium. For fibre it is an Optical Line Terminal or OLT while for copper it is a Digital Subscriber Line Access Multiplexer or DSLAM.

²⁴A Wholesale Ethernet Interconnect Link (WEIL) is a separate product with its own Product Description.

²⁵Multiple VPLS is supported for multiple resellers

Product Description – open eir NGA, Bitstream Plus

e.g. DDM1_061A eth 0/2/0

The handoff to the Operator is over a Wholesale Ethernet Interconnect (WEIL), which may be at the **same node**²⁶, i.e. within the same Local Exchange Area, or in the same Region, or in a different Region. The Operator nominates a SAB²⁶ on the WEIL on which the VLAN carrying this traffic is to be presented.

4.2 Multicast Principles

Unicast is inefficient for Broadcast TV applications where multiple end-customers simultaneously consume the same information. Even if hundreds of consumers were watching the same TV Station, each would receive a unique stream from the Service Head-end.

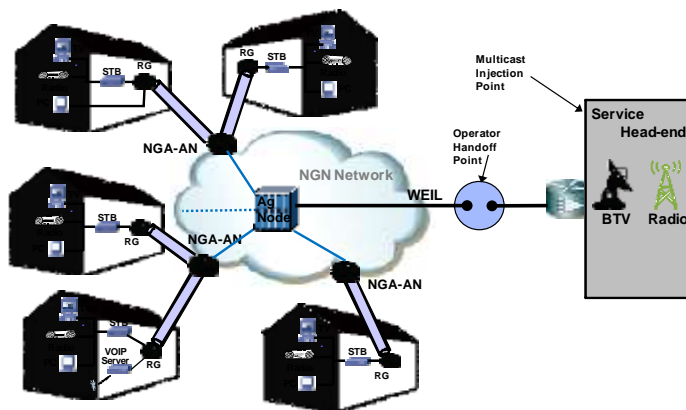

Figure 6: Multicast Principles

With Multicast, see [Figure 6](#), a single copy of each stream, e.g. every TV Channel offered by an Operator, is carried from the Operator's hand-off point, through the core network, to the NGA-AN and through the access network. At no point in this path is the broadcast stream replicated unnecessarily.

The CPE (e.g. a Set-top Box) on the end-users premises uses the Internet Group Management Protocol (IGMP) for requests to "Join" or "Leave" a broadcast stream. The End-User's CPE sends an IGMP Join to multicast group 239.1.1.1 (IGMP v.2 is supported) to the ONT/DSLAM.

²⁶Service Access Bandwidth (SAB) is a logical partitioning of bandwidth in the WEIL.

Product Description – open eir NGA, Bitstream Plus

4.3 Bitstream Plus Multicast

All open eir NGA Bitstream Plus products support Multicast²⁷, which is available as an additional service. Internet Group Management Protocol (IGMP) Version 2 and Version 3 are supported.

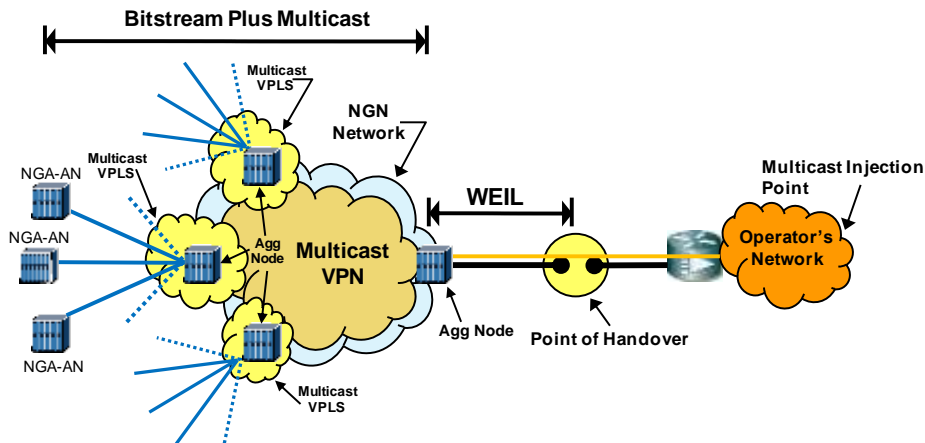

Figure 7: Bitstream Plus Multicast Service

Where Multicast is required for a single Egress Group, a dedicated VPLS, to handle all Multicast broadcasts within a NGN Aggregation Node is set up. All VPLS's for an Operator are joined to a single Multicast-VPN (M-VPN), as shown in [Figure 7](#). Multicast traffic can be presented on a VLAN on the same SAB as the Unicast traffic, or on a dedicated SAB as shown in [Figure 9](#).²⁸ Using a Multicast-VPN means that each Operator can use any valid Multicast Address Range - even where Multicast IP Addresses overlap between different Operators using the open eir Network. Further details are given in the Bitstream Plus & Virtual Unbundled Access Technical Handbook.

Formatted: English (U.K.)

Formatted: English (U.K.)

Where Multicast is required for multiple Egress Groups, a dedicated VPLS, to handle all Multicast broadcasts within a NGN Aggregation Node is set up for each Egress Group, as shown in [Figure 8](#).

²⁷Some current generation Bitstream Plus products do not support Multicast.

²⁸It is the Operators responsibility to nominate the WEIL and SAB on which each VLAN is to be presented.

Product Description – open eir NGA, Bitstream Plus

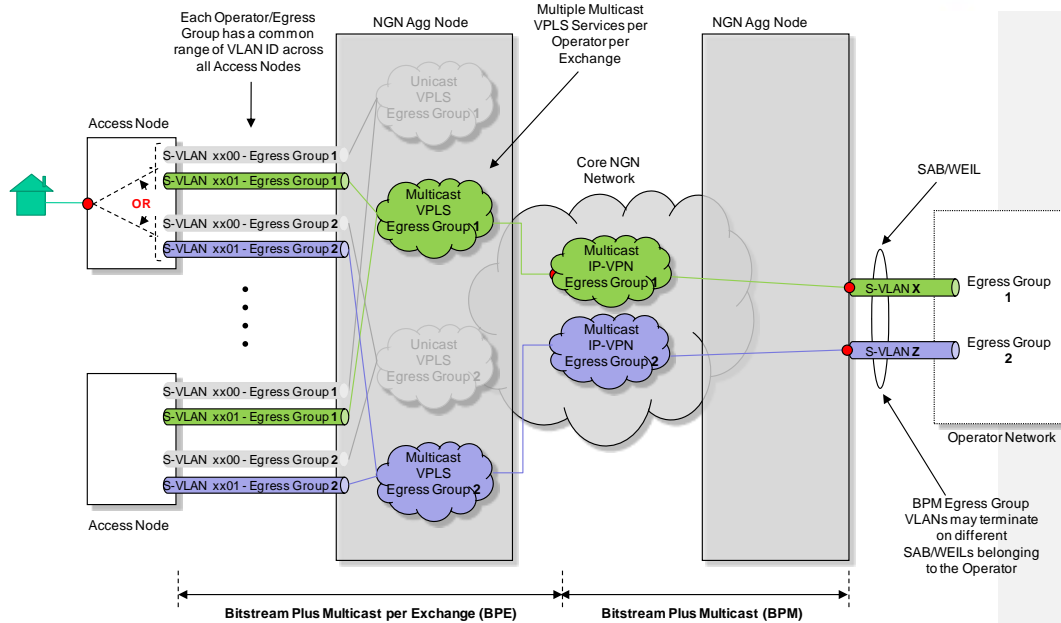

11

Figure 8: Bitstream Plus Multicast Service with multiple Egress Groups

4.4 Operators Handoff Point

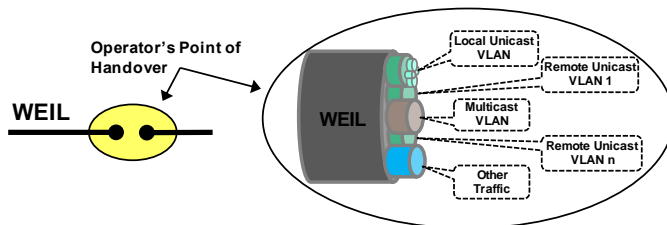

Figure 9: Operators Handoff Point

A standard WEIL product²⁹ is used to provide the interconnect link between open eir's and the Operator's networks. While the WEIL is a separate product, it is important to outline how the WEIL interacts with the NGA Bitstream Plus products. The Operator nominates the WEIL and SAB on which each VLAN is to be presented³⁰. This gives the Operator maximum flexibility, when configuring their solutions. A typical configuration, where a single WEIL is used for all for all Operator Traffic, is shown in [Figure 9](#). Multicast traffic is injected on a single VLAN, and uses a dedicated SAB. Unicast traffic from multiple Local Exchange Areas is presented in a single SAB. Multiple Unicast SAB's to allow a level of geographic separation, are used. Other traffic³¹ is presented on a separate SAB, as requested by the Operator.

Multiple Handoff WEILs

The Bitstream Plus service supports multiple handoff WEILs, which could be geographically dispersed within the NGN footprint. Multiple handoffs allow highly available solutions, with multi-site resilience, be built. Traffic can also be managed on a geographic basis, as Operator needs dictate. Multiple 'Multicast Injection Points', allow broadcast feed diversity or more efficient handling of regional content. Where multiple WEIL's are provided, the Operator nominates the WEIL and SAB on which each individual VLAN is to be presented.

²⁹As described in the Wholesale Ethernet Interconnect Link (WEIL) Product Description.

³⁰Note that this is per Egress Group

³¹Traffic that is not Bitstream Plus related.



Product Description – open eir NGA, Bitstream Plus

4.5 Traffic-based Class of Service

All traffic carried in Access Network will be assigned to one of three Class of Service (CoS) queues:

- Expedited Forwarding (EF)
- Assured Forwarding (AF)
- Standard or Best Effort (BE)

The Operator can dynamically map their end-user traffic, to any one of these three categories. This provides an Operator with the ability to manage and prioritise their upstream and downstream traffic.

Upstream and downstream traffic should be marked using 802.1p marking.³² The marking scheme is as follows:

C-VLAN 802.1p Marking	Forwarding Class
4	EF
2	AF
0	BE

Figure 10: Mapping of C-VLAN p-bits to Forwarding Classes

This marking will be honoured in the Access Network and the Wholesale Ethernet Interconnect Link (WEIL) at the Operators Handoff point. Traffic with other 802.1p markings, not specified above, will be mapped to the STD (Best Effort) queue.

4.6 CPE Management

Operators can implement their own device management platform for their Residential Gateway (RG) and other CPE³³, e.g. using a protocol for communication with the RG over the open eir network. (TR69 Remote Device Protocol is one such protocol.)

³²For Multicast, an EF CoS will be automatically applied.

³³In this context CPE (Customers Premises Equipment) refers to Operator's equipment, subsequent to the Service Termination Point.

4.7 Ordering the Bitstream Plus Logical Connectivity Service

Orders for the Bitstream Plus Logical Connectivity Service (Bitstream Plus Unicast and Bitstream Plus Multicast) use the Unified Gateway Infrastructure Orders.³⁴The Bitstream Plus logical connectivity service consists of a number of individual components, each of which must be ordered separately³⁵.

Bitstream Plus Unicast

BPU – Bitstream Plus Unicast, is the set-up of the Unicast VPLS and the connectivity between the NGN Aggregation Node and the Operator’s WEIL. This connectivity need only be ordered once per NGN Aggregation Node per Egress Group. Additional Access Nodes will be joined to each VPLS, by open eir, as the Bitstream Plus footprint expands.

Bitstream Plus Multicast

This is the set-up of the Multicast VPLS and the connectivity between the NGN Aggregation Node and the Operator’s WEIL. There are two distinct elements, as shown in [Figure 11](#).

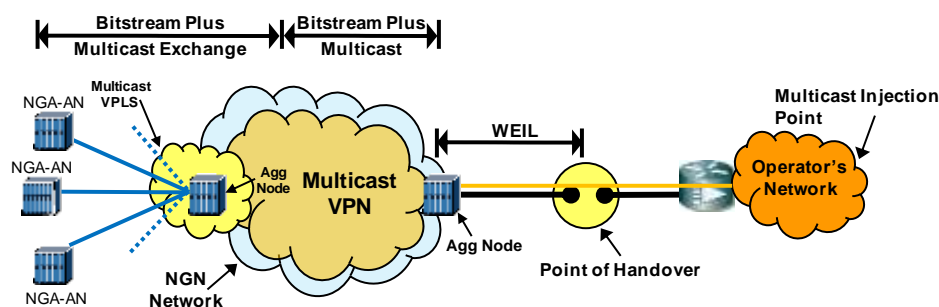

Figure 11: Bitstream Plus Multicast Orders

- **BPM** – Bitstream Plus Multicast – is the configuration of the Multicast service, for an individual Operator’s Egress Group. This capability need only be ordered once.
- **BPE** – Bitstream Plus Exchange – is configuration of the Multicast service per Egress Group, for an individual Local Exchange Area, and the connectivity to the WEIL. This connectivity must be ordered individually, for each Local Exchange Area.

³⁴There will be no Change Orders available to move a Unicast (or Multicast) VLAN to a different SAB/WEIL. Operators should place an order for the new VLAN to be delivered on the specified SAB/WEIL. When the new VLAN has been delivered the Operator can then place a Cease Order for the original VLAN.

³⁵An Operator must first order a Wholesale Ethernet Interconnect Link, before they can order any Bitstream Plus service.

5. FTTH Bitstream Plus

FTTH Bitstream Plus Access provides high speed broadband over a Fibre-based Gigabit-capable Passive Optical Network (GPON) network, which uses 1:32 optical splitters in the cabinets.

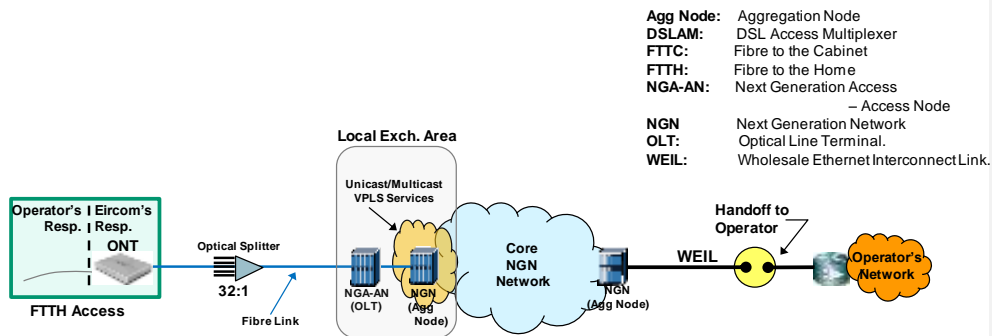

Figure 12: FTTH Bitstream Plus Standalone

Three customer port speeds are supported, 150Mb/s Downstream with 30Mb/s Upstream, 300Mb/s Downstream with 50Mb/s Upstream and 1Gb/s Downstream with 100Mb/s Upstream.

5.1 FTTH Bitstream Plus POTS-Based

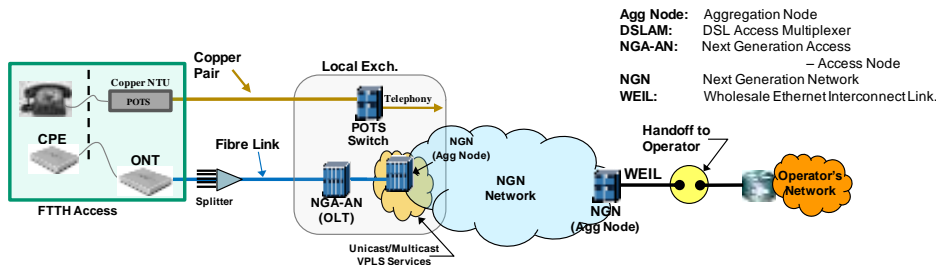

Figure 13: FTTH Bitstream Plus POTS-Based

FTTH Bitstream Plus POTS-Based supports a PSTN voice telephony service, as well as all the features of FTTH Bitstream Plus Standalone. The PSTN service is supplied on a copper access pair, in parallel with the fibre Gigabit Ethernet port of the ONT³⁶ at the end-customers' premises, is the demarcation point for Broadband. A Copper NTU³⁷ is the demarcation point for PSTN.

³⁶Optical Network Terminal.

³⁷ The technical specification for the Copper NTU is given in the Technical Manual.

5.2 FTTH Bitstream Plus GEA

The end customer will have asymmetric bandwidth options over GPON Ethernet Access. The configurable bandwidth is dependent on the product option selected.

Formatted: Normal, Space Before: 0 pt, After: 0 pt, Line spacing: single, No bullets or numbering, Border: Bottom: (No border)

Figure 14 below specifies the access of bandwidth options supported on the GEA Ethernet Access service.

Formatted: Left, Space Before: 0 pt, After: 0 pt, Line spacing: single, Tab stops: 1.5 cm, Left

<u>Downstream Speed (Mbps)</u>	<u>Upstream Speed (Mbps)</u>
<u>100</u>	<u>20</u>
<u>250</u>	<u>40</u>
<u>400</u>	<u>60</u>

Formatted: Not Highlight

Formatted: Font: GT Walsheim Regular, Not Bold, English (Ireland)

Formatted Table

Figure 15 below specifies the WES bandwidths associated with the different GEA bandwidth profiles:

Formatted: Font: GT Walsheim Regular

Formatted: Font: GT Walsheim Regular

<u>Downstream Speed (Mbps)</u>	<u>Upstream Speed (Mbps)</u>
<u>100</u>	<u>20</u>
<u>250</u>	<u>40</u>
<u>400</u>	<u>60</u>

The WES bandwidth profile will be applied on the SAP on the NGN Aggregation node associated with the GEA connection as well as on the SAP on the NGN Aggregation node associated with the EIL connection. An asymmetrical QoS profile will be deployed on the SAP associated with the GEA connection which will be referenced from the effective downstream bandwidth.

Formatted: Font: GT Walsheim Regular

Formatted: Font: GT Walsheim Regular

Formatted: Font: GT Walsheim Regular

Formatted: Font: GT Walsheim Regular

Formatted: Left

Formatted: Normal, Space Before: 0 pt, After: 0 pt, Line spacing: single, No bullets or numbering, Border: Bottom: (No border)

Formatted: Font: Arial

Product Description – open eir NGA, Bitstream Plus

5.3 FTTH Bitstream Plus GEA QoS

Quality of Service (QoS) will be applied to the logical circuit, i.e. the WES, at the NGN AGG nodes and is based on the standard models and forwarding classes supported on the NGN network for Wholesale NGN Ethernet. Circuit based QoS only will be supported.

Forwarding classes are Assured Forwarding (AF), and standard/best effort (BE) classes.

There will be 2 Circuit based QoS options defined for the 3 different product speeds for the GEA Ethernet Access Product as follows (The percentage values in the table refer to the percentage of the WES bandwidth).

Formatted: Font: GT Walsheim Regular

<u>Circuit QoS</u>	<u>% AF</u>	<u>%BE</u>
<u>Option 1</u>	<u>0%</u>	<u>100%</u>
<u>Option 2</u>	<u>10%</u>	<u>90%</u>

Figure 16: GEA Ethernet Access traffic based QoS Options

Formatted: Font: Not Bold

5.25.4 FTTH Bitstream Plus Service Presentation

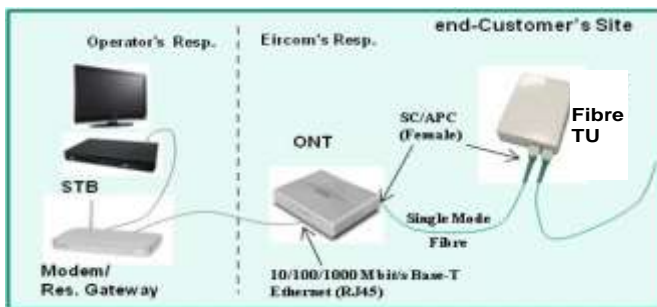

Figure 14: Fibre STP for FTTH

The end-customer Service Termination Point (STP), for all services delivered over fibre, is a Gigabit Ethernet Port on the Optical Network Terminal (ONT). This is an auto-sensing 10/100/1000Base-T Ethernet port (suitable for the insertion of a RJ-45 connector). A single mode fibre patch cord will be used to connect the female (adapter) SC/APC connector of the Fibre Terminating Unit to the female (adapter) single mode SC/APC connector of the ONT.

Where POTS is provided, it is delivered over a separate copper pair and has a separate demarcation point on a copper Network Terminating Unit (NTU). Further information on the service presentation, including the technical specification for the Copper NTU, can be found in the Bitstream Plus & Virtual Unbundled Access Technical Handbook.

The End-User traffic presented at the ONT will be VLAN tagged (VLAN 10). The End-User CPE will generate the 802.1p VLAN ID=10 frames.

ONT Specification:

Power adapter input: 100–240 VAC, 50–60 Hz



Product Description – open eir NGA, Bitstream Plus

End-User Facing Port: Auto-sensing 10/100/1000M Base-T Ethernet port (RJ-45)

6. FTTC Bitstream Plus

FTTC Bitstream Plus Access provides high speed broadband over a dedicated copper pair using VDSL2 technologies from a kerbside cabinet. The kerbside cabinet is connected direct to the exchange via fibre. The bandwidth available to an individual end-customer depends on the characteristics of their copper line.³⁸

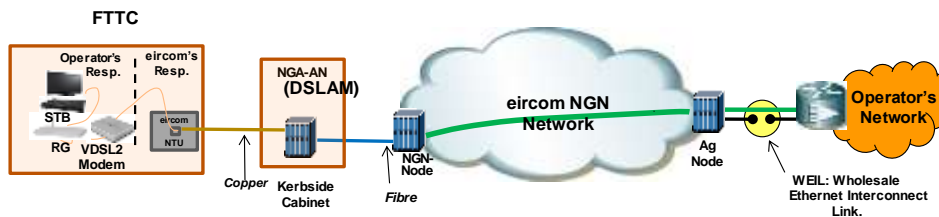

Figure 15: FTTC Standalone Bitstream Plus

The customer port speed depends on the characteristics of the individual sub-loop up to a maximum speed of 100Mb/s Downstream, 20Mb/s Upstream.

Formatted: Left

6.1 FTTC Bitstream Plus POTS-Based

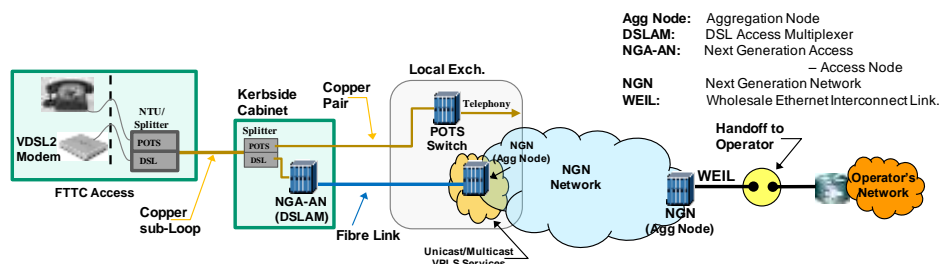

Figure 16: FTTC Bitstream Plus POTS-Based

FTTC Bitstream Plus POTS-based supports a PSTN voice telephony service, as well as all the features of standalone FTTC Bitstream Plus, on a single copper pair. All existing SB-WLR functionality and associated Ancillary Services are available. The dual NTU/Splitter, at the end-customer's premises, is the service termination point. The demarcation point is the copper NTU at the end-user premises; an RJ11 interface is provided for POTS and an RJ45 is provided for VDSL.

The End-User traffic presented at the NTU will be VLAN tagged (VLAN 10). The End-User CPE will generate the 802.1p VLAN ID=10 frames

³⁸In this instance the 'copper line' is the copper twisted pair linking the customer's premises to the kerbside cabinet. This is often referred to as the 'copper sub-loop'.

6.2 FTTC Line Profiles

A 'Profile' is a set of configuration parameters that govern how a DSL line operates. The FTTC Line Profile determines the maximum downstream and upstream speed for that end-customer and whether that speed is fixed or adapts to varying line conditions. The Bitstream Plus FTTC Access Product supports two profile ranges – one for 'High Speed Internet' and one 'Stable or Non Rate-adaptive' range, intended primarily for Broadcast TV.

Stable/Multicast		High Speed Internet	
Downstream	Upstream	Downstream	Upstream
100	20	100	20
85	20	90	20
80	20	80	20
70	20	70	20
60	20	60	20
50	16	50	20
43	16	50	15
40	16	40	10
34	16	30	8
28	15	25	7
20	10	18	5
20	8	15	3
18	7	12	1
12	1	7	1
10	1		
4	1		

Figure 17: FTTC Profiles

The High Speed Internet (HSI) range is 'Rate Adaptive' in both directions – this means that the line speed in each direction varies, depending on local line conditions, up to the maximum value specified by the profile currently set on that line. The 'Stable' range is 'Rate Adaptive' upstream and 'Fixed' downstream. This means that the downstream speed is set by the applied profile and does not vary. High Speed Internet or Stable/ Non-rate adaptive is selected at Order Submission, but can be changed subsequently.



Product Description – open eir NGA, Bitstream Plus

6.3 FTTC Bitstream Plus VEA

The end customer will have asymmetric bandwidth options over VDSL Ethernet Access. The **configurable bandwidth is dependent on the physical distance between the customer’s premises and the Cabinet DSLAM.**

There are 2 types of VDSL profiles that will be provisioned on the customers’ lines;

- Rate adaptive profiles
- Fix rate profiles

It is currently proposed to have one rate adaptive profile (100Mb) and three fixed rate profiles (70Mb, 50Mb and 20Mb).

The VEA bandwidth profile (VDSL profile) will be applied on the customer facing port on the DSLAM. The actual service or effective will be configured on the WES logical service (excludes VDSL protocol overheads). The Effective Bandwidth (EVC bandwidth) is approximately 90% of the VDSL access bandwidth profile.

The WES bandwidth profile will be applied on the SAP at the NGN Aggregation Node associated with the VEA connection as well as on the SAP at the NGN AGG Node associated with the EIL connection.

A symmetrical QoS profile (same QoS for SAP-ingress and SAP-egress) will be deployed at the SAP associated with the VEA connection which will be referenced from the effective downstream bandwidth.

Figure 16 below specifies the proposed range of bandwidth profiles supported on the VDSL Ethernet Access service.

Downstream (Mbps)	Upstream (Mbps)		Effective Bandwidth (Mbps)
	Maximum	Minimum	
100	20	1	90.0

Rate Adaptive Profile

Downstream (Mbps)	Upstream (Mbps)		Effective Bandwidth (Mbps)
	Maximum	Minimum	
70	20	5	63.0
50	16	5	45
20	8	2.5	18

Stable Profiles

Figure 18: Bitstream Plus VDSL Ethernet Access Bandwidth Profiles



Product Description – open eir NGA, Bitstream Plus

6.4 FTTC Bitstream Plus VEA QoS

Quality of Service (QoS) will be applied to the logical circuit, i.e the WES, at the NGN AGG nodes and is based on the standard models and forwarding classes supported on the NGN network for Wholesale NGN Ethernet. Both traffic and circuit based QoS will be supported.

Forwarding classes are Expedited Forwarding (EF), Assured Forwarding (AF), and standard/best effort (STD) classes.

Standard Circuit based and traffic based QoS models will be supported over the Fixed Rate VDSL profiles. Standard QoS (STD) only will be supported for the Rate Adaptive profiles.

It is proposed to include 8 Traffic Based options as well as the 6 Circuit Based options that are in place already for the NGN products

The following range of Circuit and Traffic Based QoS options have been defined for VDSL Ethernet Access.

Circuit based QoS	Traffic Based QoS
Opt 1 (100% EF)	100% Best Efforts
Opt 2 (50% AF)	20% AF
Opt 3 (10% AF)	5% EF
Opt 4 (5% AF)	5% EF 20%AF
Opt 5 (100% BE)	5% EF 50% AF
Opt 6 (100% AF)	10% EF 0% AF
	10%EF 20% AF
	10% EF 50% AF

Figure 19: VDSL Ethernet Access QoS Options



Product Description – open eir NGA, Bitstream Plus

7. Bitstream Plus Access – Ordering and Assurance

The Unified Gateway (UG) should be used for all orders in relation to the provisioning or assurance of the Bitstream Plus Access products. The products will be available within a defined footprint which will be published on the open eir website. The product may be ordered for new end-customer connections and a suite of both inter-Operator and intra-Operator order types are available. The Multicast element may be ordered as part of the initial transaction, or may be added at a later date. For the Bitstream Plus VEA ~~and products~~ [GEA products](#) the QoS element may be ordered as part of the initial transaction, or may be added at a later date. In addition to the normal ordering activity, Operators have the ability to amend the end-customer line profile, for the FTTC delivery mechanism. The UG will process and validate the relevant orders and will provide appropriate notifications for Acceptance and Delivery.

More detailed information can be found in the NGA Bitstream Plus and Virtual Unbundled Access Industry Process Manual.

8. Billing

There are connection, usage, and rental charges associated with the Bitstream Plus NGA Product. Once an order is completed billing shall commence in the next billing cycle.

In the event that an Operator has a query regarding the bill, they should contact their open eir Customer Relationship Manager.

9. Commercial

9.1 Pricing

Prices for the open eir NGA Bitstream Plus Product will be published in the relevant open eir Price List.

9.2 Terms and Conditions

Terms and conditions will be published in the relevant open eir Agreement.



Version Control History

Version	Status	Update	Effective Date
1.0		Notification Issue	October 18th 2012
2.0		Added Section 3.7 and Section 3.8	April 15th 2013
2.1		Additional HSI Profiles added to Table 15	July 9th 2013
2.2		Additional Stable Profiles added to Table 15	September 6th 2013
2.3		Additional HSI and Stable Profiles added to Table 15 (vectoring). Reference to FTTC CPE requirements of Technical Handbook added to Section 3.7. Table 15 updated to reflect that all vectoring and non-vectoring profiles will remain in place until vectoring is fully rolled out (as advised at the NGA Forum on 5th February 2014)	February 7th 2014
2.4		Addition of new Profiles to Section 5 & 6 Minor correction to text in Section 6	January 30th 2015
2.5		Addition of Wholesale Bitstream Plus VDSL Ethernet Access Services over FTTC (VEA)	April 2nd 2015
2.6		Addition of Copper Line Minimum Standard - Section 3.2	November 2nd 2015
V3.0	Final	This document is based on V2.6 Implementation of Standardised Change Control.	16/06/2017
V3.1	Proposed	Addition of Wholesale Bitstream Plus GPON Ethernet Access Services over FTTH (GEA)	01/09/ 2019